



Is Now Part of



**ON Semiconductor®**

To learn more about ON Semiconductor, please visit our website at

[www.onsemi.com](http://www.onsemi.com)

ON Semiconductor and the ON Semiconductor logo are trademarks of Semiconductor Components Industries, LLC dba ON Semiconductor or its subsidiaries in the United States and/or other countries. ON Semiconductor owns the rights to a number of patents, trademarks, copyrights, trade secrets, and other intellectual property. A listing of ON Semiconductor's product/patent coverage may be accessed at [www.onsemi.com/site/pdf/Patent-Marking.pdf](http://www.onsemi.com/site/pdf/Patent-Marking.pdf). ON Semiconductor reserves the right to make changes without further notice to any products herein. ON Semiconductor makes no warranty, representation or guarantee regarding the suitability of its products for any particular purpose, nor does ON Semiconductor assume any liability arising out of the application or use of any product or circuit, and specifically disclaims any and all liability, including without limitation special, consequential or incidental damages. Buyer is responsible for its products and applications using ON Semiconductor products, including compliance with all laws, regulations and safety requirements or standards, regardless of any support or applications information provided by ON Semiconductor. "Typical" parameters which may be provided in ON Semiconductor data sheets and/or specifications can and do vary in different applications and actual performance may vary over time. All operating parameters, including "Typicals" must be validated for each customer application by customer's technical experts. ON Semiconductor does not convey any license under its patent rights nor the rights of others. ON Semiconductor products are not designed, intended, or authorized for use as a critical component in life support systems or any FDA Class 3 medical devices or medical devices with a same or similar classification in a foreign jurisdiction or any devices intended for implantation in the human body. Should Buyer purchase or use ON Semiconductor products for any such unintended or unauthorized application, Buyer shall indemnify and hold ON Semiconductor and its officers, employees, subsidiaries, affiliates, and distributors harmless against all claims, costs, damages, and expenses, and reasonable attorney fees arising out of, directly or indirectly, any claim of personal injury or death associated with such unintended or unauthorized use, even if such claim alleges that ON Semiconductor was negligent regarding the design or manufacture of the part. ON Semiconductor is an Equal Opportunity/Affirmative Action Employer. This literature is subject to all applicable copyright laws and is not for resale in any manner.

## BS270 N-Channel Enhancement Mode Field Effect Transistor

### General Description

These N-Channel enhancement mode field effect transistors are produced using Fairchild's proprietary, high cell density, DMOS technology. These products have been designed to minimize on-state resistance while provide rugged, reliable, and fast switching performance. They can be used in most applications requiring up to 500mA DC. These products are particularly suited for low voltage, low current applications such as small servo motor control, power MOSFET gate drivers, and other switching applications.

### Features

- 400mA, 60V.  $R_{DS(ON)} = 2\Omega @ V_{GS} = 10V$ .
- High density cell design for low  $R_{DS(ON)}$ .
- Voltage controlled small signal switch.
- Rugged and reliable.
- High saturation current capability.

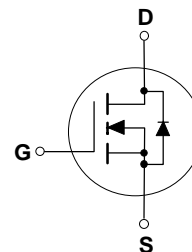
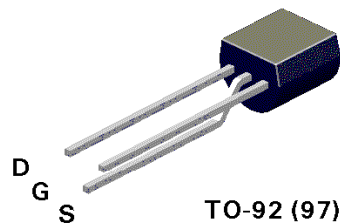

### Absolute Maximum Ratings $T_A = 25^\circ\text{C}$ unless otherwise noted

Symbol	Parameter	BS270	Units
$V_{DSS}$	Drain-Source Voltage	60	V
$V_{DGR}$	Drain-Gate Voltage ( $R_{GS} \leq 1M\Omega$ )	60	V
$V_{GSS}$	Gate-Source Voltage - Continuous - Non Repetitive ( $t_p < 50\mu\text{s}$ )	$\pm 20$	V
		$\pm 40$	
$I_D$	Drain Current - Continuous - Pulsed	400	mA
		2000	
$P_D$	Maximum Power Dissipation Derate Above $25^\circ\text{C}$	625	mW
		5	mW/ $^\circ\text{C}$
$T_J, T_{STG}$	Operating and Storage Temperature Range	-55 to 150	$^\circ\text{C}$
$T_L$	Maximum Lead Temperature for Soldering Purposes, 1/16" from Case for 10 Seconds	300	$^\circ\text{C}$

### THERMAL CHARACTERISTICS

$R_{\theta JA}$	Thermal Resistacne, Junction-to-Ambient	200	$^\circ\text{C/W}$
-----------------	---	-----	--------------------

**Electrical Characteristics** ( $T_A = 25^\circ\text{C}$  unless otherwise noted)

Symbol	Parameter	Conditions	Min	Typ	Max	Units
<b>OFF CHARACTERISTICS</b>						
$BV_{DSS}$	Drain-Source Breakdown Voltage	$V_{GS} = 0\text{ V}, I_D = 10\ \mu\text{A}$	60			V
$I_{DSS}$	Zero Gate Voltage Drain Current	$V_{DS} = 60\text{ V}, V_{GS} = 0\text{ V}$ $T_J = 125^\circ\text{C}$			1	$\mu\text{A}$
					500	$\mu\text{A}$
$I_{GSSF}$	Gate - Body Leakage, Forward	$V_{GS} = 20\text{ V}, V_{DS} = 0\text{ V}$			10	nA
$I_{GSSF}$	Gate - Body Leakage, Reverse	$V_{GS} = -20\text{ V}, V_{DS} = 0\text{ V}$			-10	nA
<b>ON CHARACTERISTICS</b> (Note 1)						
$V_{GS(th)}$	Gate Threshold Voltage	$V_{DS} = V_{GS}, I_D = 250\ \mu\text{A}$	1	2.1	2.5	V
$R_{DS(on)}$	Static Drain-Source On-Resistance	$V_{GS} = 10\text{ V}, I_D = 500\text{ mA}$ $T_J = 125^\circ\text{C}$		1.2	2	$\Omega$
			$V_{GS} = 4.5\text{ V}, I_D = 75\text{ mA}$		1.8	3
$V_{DS(on)}$	Drain-Source On-Voltage	$V_{GS} = 10\text{ V}, I_D = 500\text{ mA}$ $V_{GS} = 4.5\text{ V}, I_D = 75\text{ mA}$		0.6	1	V
				0.14	0.225	
$I_{D(on)}$	On-State Drain Current	$V_{GS} = 10\text{ V}, V_{DS} \geq 2 V_{DS(on)}$ $V_{GS} = 4.5\text{ V}, V_{DS} \geq 2 V_{DS(on)}$	2000	2700		mA
			400	600		
$g_{FS}$	Forward Transconductance	$V_{DS} \geq 2 V_{DS(on)}, I_D = 200\text{ mA}$	100	320		mS
<b>DYNAMIC CHARACTERISTICS</b>						
$C_{iss}$	Input Capacitance	$V_{DS} = 25\text{ V}, V_{GS} = 0\text{ V},$ $f = 1.0\text{ MHz}$		20	50	pF
$C_{oss}$	Output Capacitance			11	25	pF
$C_{rss}$	Reverse Transfer Capacitance			4	5	pF
<b>SWITCHING CHARACTERISTICS</b> (Note 1)						
$t_{on}$	Turn-On Time	$V_{DD} = 30\text{ V}, I_D = 500\text{ mA},$ $V_{GS} = 10\text{ V}, R_{GEN} = 25\ \Omega$			10	ns
$t_{off}$	Turn-Off Time				10	ns
<b>DRAIN-SOURCE DIODE CHARACTERISTICS AND MAXIMUM RATINGS</b>						
$I_S$	Maximum Continuous Drain-Source Diode Forward Current			400		mA
$I_{SM}$	Maximum Pulsed Drain-Source Diode Forward Current			2000		mA
$V_{SD}$	Drain-Source Diode Forward Voltage	$V_{GS} = 0\text{ V}, I_S = 400\text{ mA}$ (Note 1)		0.88	1.2	V

Note:

 1. Pulse Test: Pulse Width  $\leq 300\ \mu\text{s}$ , Duty Cycle  $\leq 2.0\%$ .

## Typical Electrical Characteristics

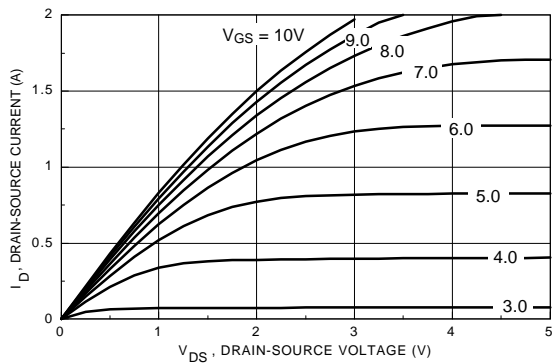

Figure 1. On-Region Characteristics.

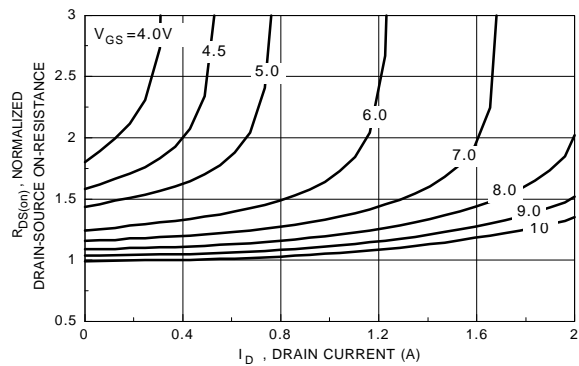

Figure 2. On-Resistance Variation with Gate Voltage and Drain Current.

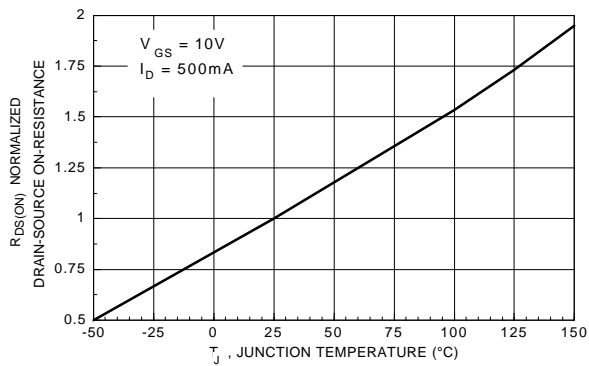

Figure 3. On-Resistance Variation with Temperature.

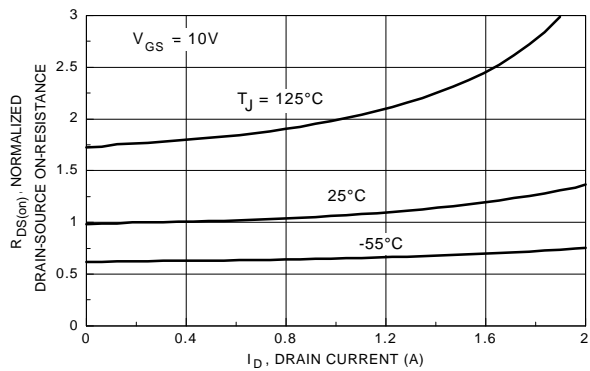

Figure 4. On-Resistance Variation with Drain Current and Temperature.

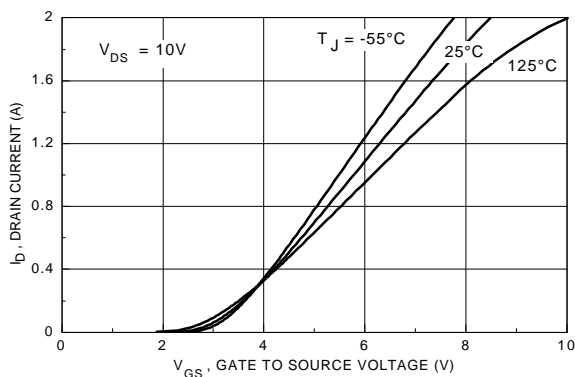

Figure 5. Transfer Characteristics.

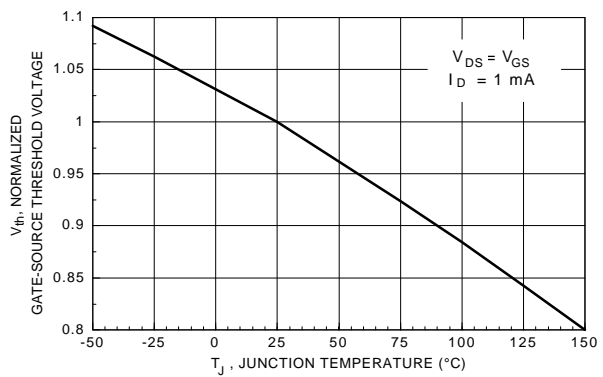
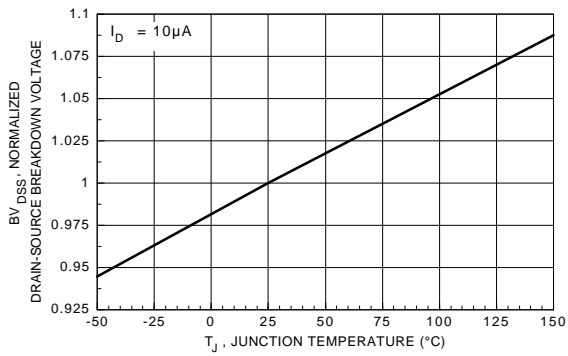
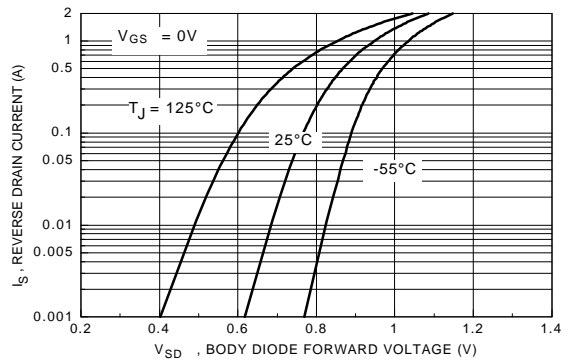

Figure 6. Gate Threshold Variation with Temperature.

## Typical Electrical Characteristics (continued)



**Figure 7. Breakdown Voltage Variation with Temperature.**



**Figure 8. Body Diode Forward Voltage Variation with Current and Temperature.**

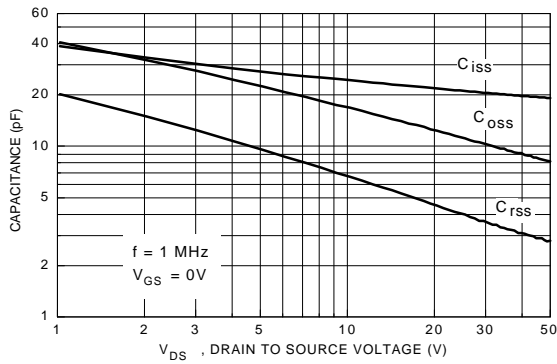

**Figure 9. Capacitance Characteristics.**

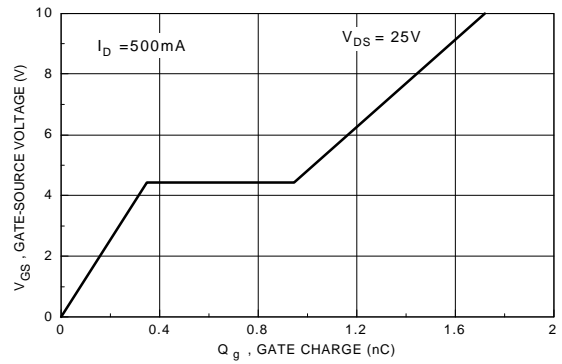

**Figure 10. Gate Charge Characteristics.**

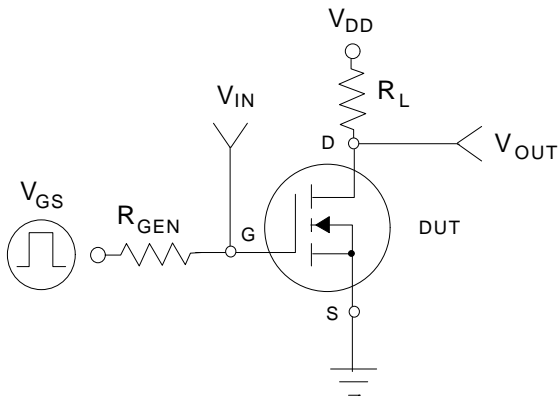

**Figure 11. Switching Test Circuit.**

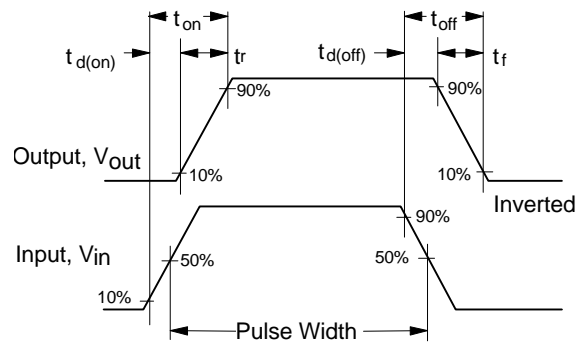

**Figure 12. Switching Waveforms.**

## Typical Electrical Characteristics (continued)

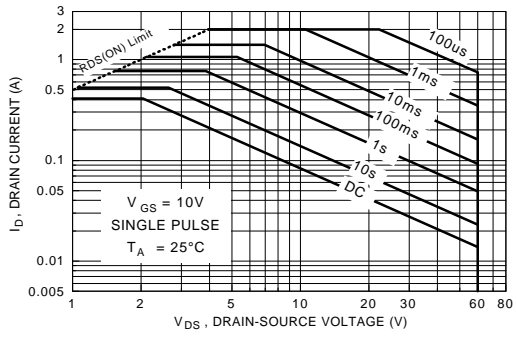

Figure 13. Maximum Safe Operating Area.

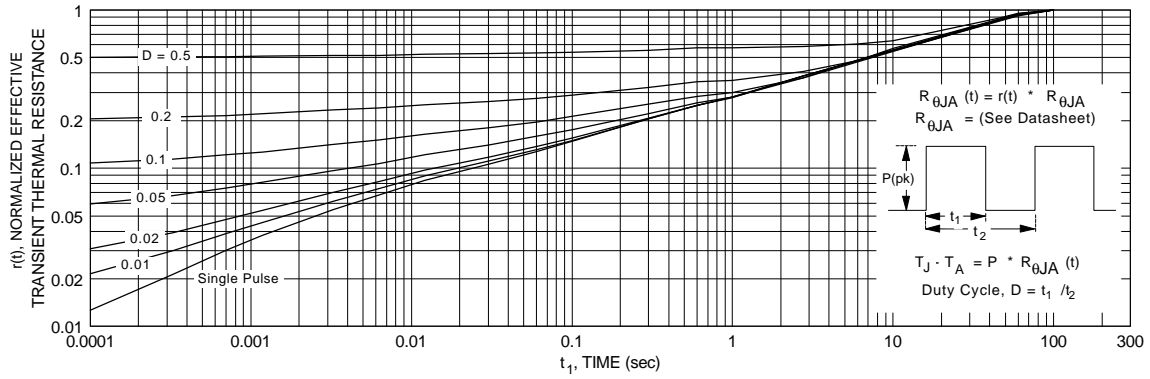

Figure 14. Transient Thermal Response Curve.

# TO-92 Tape and Reel Data



## TO-92 Packaging Configuration: Figure 1.0

FSCINT Label sample



F63TNR Label sample

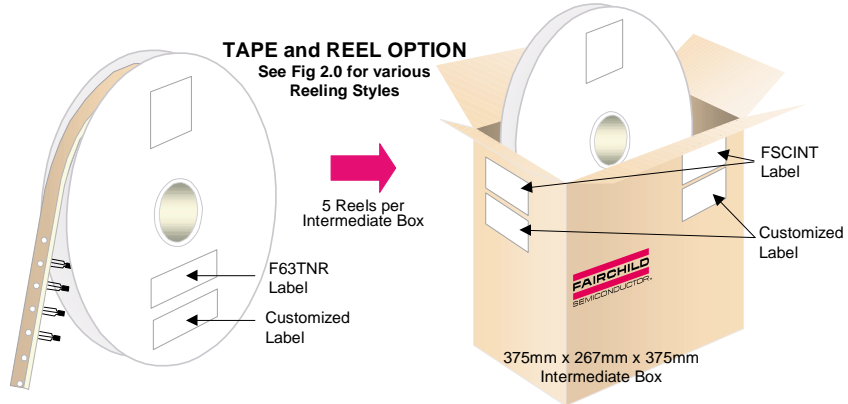

### TO-92 TNR/AMMO PACKING INFORMATION

Packing	Style	Quantity	EOL code
Reel	A	2,000	D26Z
	E	2,000	D27Z
Ammo	M	2,000	D74Z
	P	2,000	D75Z

Unit weight = 0.22 gm  
 Reel weight with components = 1.04 kg  
 Ammo weight with components = 1.02 kg  
 Max quantity per intermediate box = 10,000 units

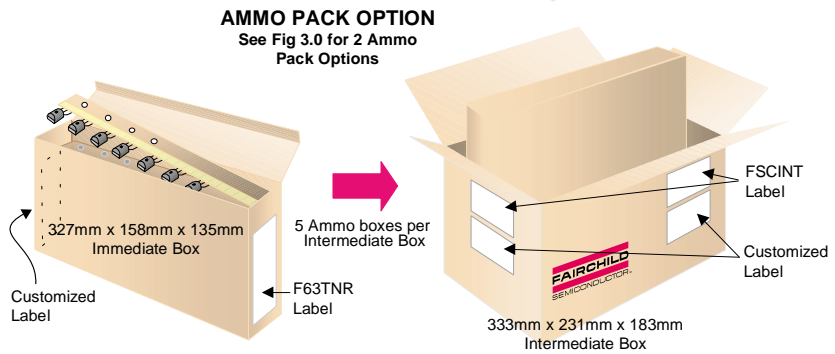

### (TO-92) BULK PACKING INFORMATION

EOL CODE	DESCRIPTION	LEADCLIP DIMENSION	QUANTITY
J18Z	TO-18 OPTION STD	NO LEAD CLIP	2.0 K / BOX
J05Z	TO-5 OPTION STD	NO LEAD CLIP	1.5 K / BOX
NO EOL CODE	TO-92 STANDARD STRAIGHT FOR: PKG 92, 94 (NON PROELECTRON SERIES), 96	NO LEADCLIP	2.0 K / BOX
L34Z	TO-92 STANDARD STRAIGHT FOR: PKG 94 (PROELECTRON SERIES BCXXX, BFXXX, BSRXXX), 97, 98	NO LEADCLIP	2.0 K / BOX

### BULK OPTION

See Bulk Packing Information table

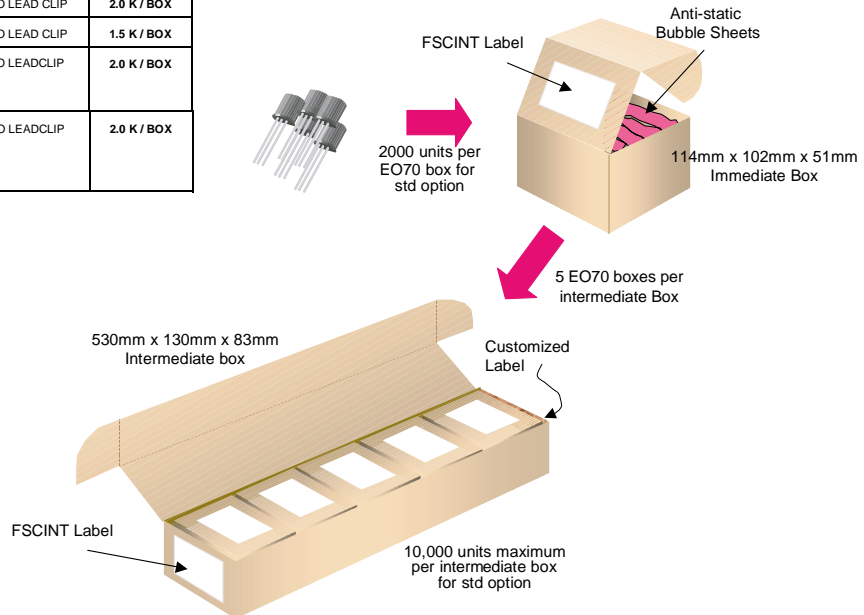

## TO-92 Tape and Reel Data, continued

### TO-92 Reeling Style

Configuration: Figure 2.0

#### Machine Option "A" (H)

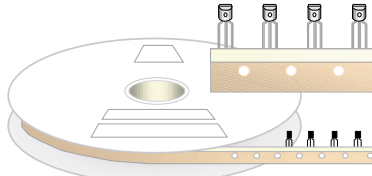

Style "A", D26Z, D70Z (s/h)

#### Machine Option "E" (J)

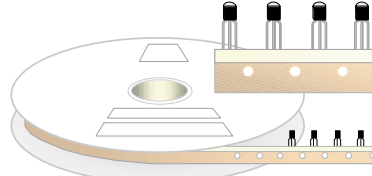

Style "E", D27Z, D71Z (s/h)

### TO-92 Radial Ammo Packaging

Configuration: Figure 3.0

FIRST WIRE OFF IS COLLECTOR  
ADHESIVE TAPE IS ON THE TOP SIDE  
FLAT OF TRANSISTOR IS ON TOP

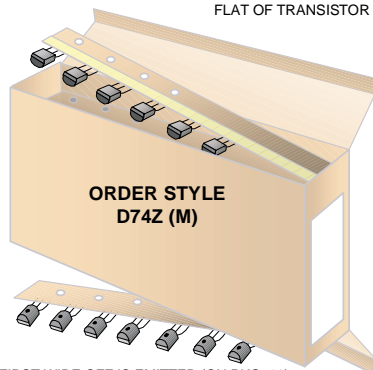

ORDER STYLE  
D74Z (M)

FIRST WIRE OFF IS EMITTER (ON PKG. 92)  
ADHESIVE TAPE IS ON BOTTOM SIDE  
FLAT OF TRANSISTOR IS ON BOTTOM

FIRST WIRE OFF IS EMITTER  
ADHESIVE TAPE IS ON THE TOP SIDE  
FLAT OF TRANSISTOR IS ON BOTTOM

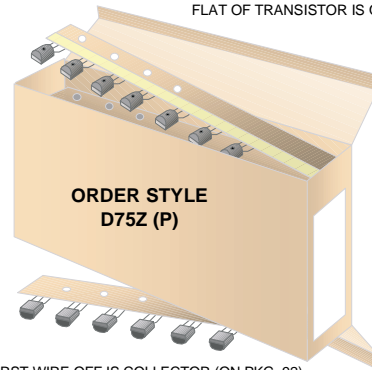

ORDER STYLE  
D75Z (P)

FIRST WIRE OFF IS COLLECTOR (ON PKG. 92)  
ADHESIVE TAPE IS ON BOTTOM SIDE  
FLAT OF TRANSISTOR IS ON TOP



# TO-92 Tape and Reel Data, continued

**TO-92 Tape and Reel Taping  
Dimension Configuration: Figure 4.0**

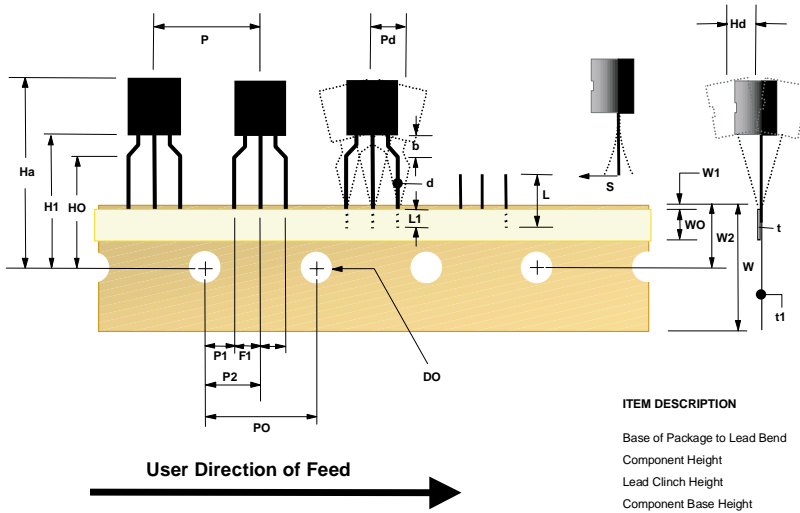

ITEM DESCRIPTION	SYMBOL	DIMENSION
Base of Package to Lead Bend	b	0.098 (max)
Component Height	Ha	0.928 (+/- 0.025)
Lead Clinch Height	HO	0.630 (+/- 0.020)
Component Base Height	H1	0.748 (+/- 0.020)
Component Alignment ( side/side )	Pd	0.040 (max)
Component Alignment ( front/back )	Hd	0.031 (max)
Component Pitch	P	0.500 (+/- 0.020)
Feed Hole Pitch	PO	0.500 (+/- 0.008)
Hole Center to First Lead	P1	0.150 (+0.009, -0.010)
Hole Center to Component Center	P2	0.247 (+/- 0.007)
Lead Spread	F1/F2	0.104 (+/- 0.010)
Lead Thickness	d	0.018 (+0.002, -0.003)
Cut Lead Length	L	0.429 (max)
Taped Lead Length	L1	0.209 (+0.051, -0.052)
Taped Lead Thickness	t	0.032 (+/- 0.006)
Carrier Tape Thickness	t1	0.021 (+/- 0.006)
Carrier Tape Width	W	0.708 (+0.020, -0.019)
Hold - down Tape Width	WO	0.236 (+/- 0.012)
Hold - down Tape position	W1	0.035 (max)
Feed Hole Position	W2	0.360 (+/- 0.025)
Sprocket Hole Diameter	DO	0.157 (+0.008, -0.007)
Lead Spring Out	S	0.004 (max)

Note : All dimensions are in inches.

**TO-92 Reel  
Configuration: Figure 5.0**

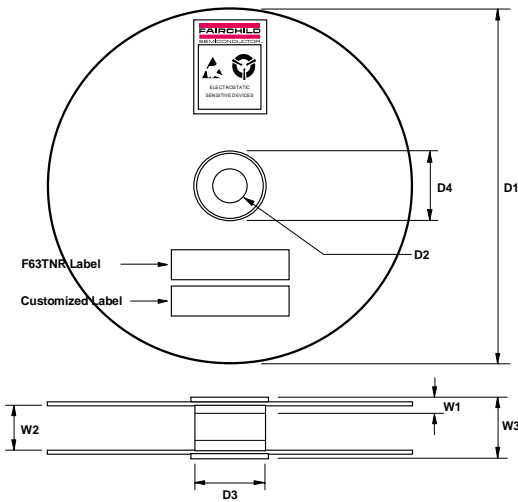

ITEM DESCRIPTION	SYMBOL	MINIMUM	MAXIMUM
Reel Diameter	D1	13.975	14.025
Arbor Hole Diameter (Standard)	D2	1.160	1.200
(Small Hole)	D2	0.650	0.700
Core Diameter	D3	3.100	3.300
Hub Recess Inner Diameter	D4	2.700	3.100
Hub Recess Depth	W1	0.370	0.570
Flange to Flange Inner Width	W2	1.630	1.690
Hub to Hub Center Width	W3		2.090

Note: All dimensions are in inches

# TO-92 Package Dimensions



## TO-92; TO-18 Reverse Lead Form (J35Z Option) (FS PKG Code 92, 94, 96)

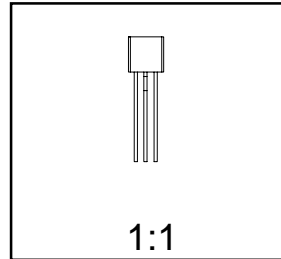
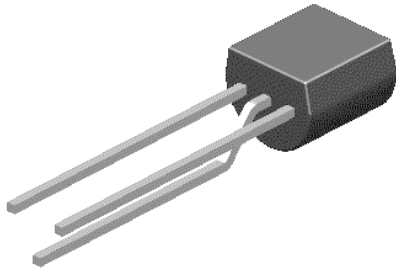

Scale 1:1 on letter size paper

Dimensions shown below are in:  
inches [millimeters]

Part Weight per unit (gram): 0.22

TO-92(92,94,96,97\*,98\*);  
TO-18 REVERSE LEADFORM  
(J35Z)

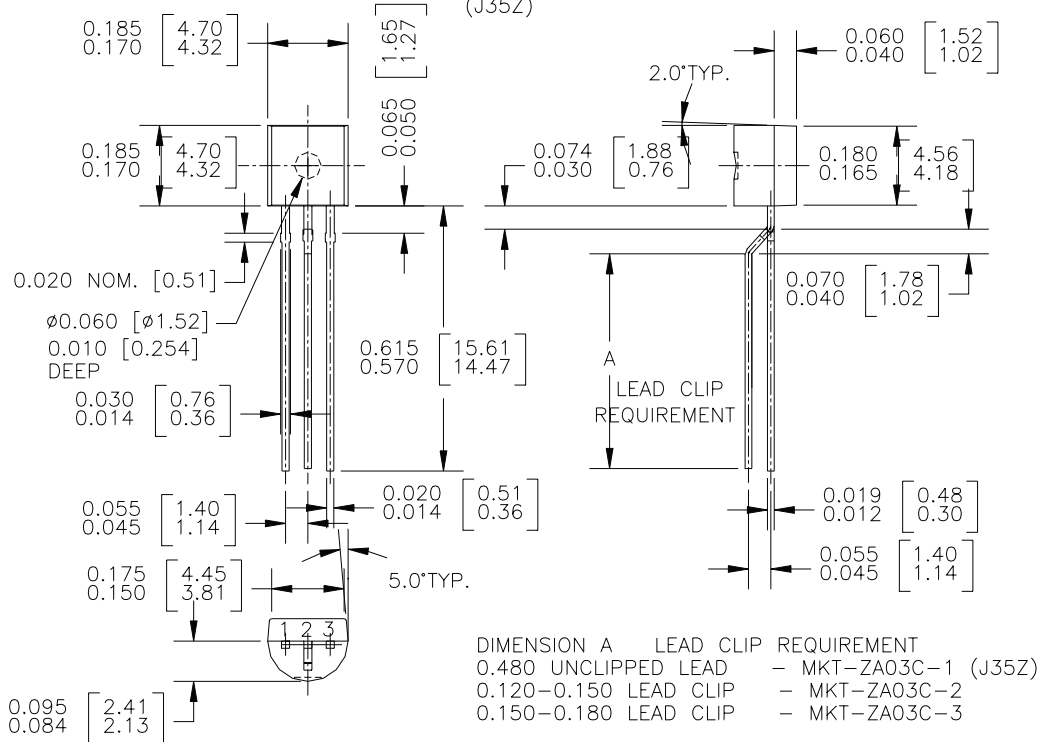

**Note:** All package 97 or 98 transistors are leadformed to this configuration prior to bulk shipment. Order L34Z option if in-line leads are preferred on package 97 or 98.

\* Standard Option on 97 & 98 package code

## TRADEMARKS

The following are registered and unregistered trademarks Fairchild Semiconductor owns or is authorized to use and is not intended to be an exhaustive list of all such trademarks.

ACEx™	FASTr™	PowerTrench®	SyncFET™
Bottomless™	GlobalOptoisolator™	QFET™	TinyLogic™
CoolFET™	GTO™	QS™	UHC™
CROSSVOLT™	HiSeC™	QT Optoelectronics™	VCX™
DOME™	ISOPLANAR™	Quiet Series™	
E <sup>2</sup> CMOS™	MICROWIRE™	SILENT SWITCHER®	
EnSigna™	OPTOLOGIC™	SMART START™	
FACT™	OPTOPLANAR™	SuperSOT™-3	
FACT Quiet Series™	PACMAN™	SuperSOT™-6	
FAST®	POP™	SuperSOT™-8	

## DISCLAIMER

FAIRCHILD SEMICONDUCTOR RESERVES THE RIGHT TO MAKE CHANGES WITHOUT FURTHER NOTICE TO ANY PRODUCTS HEREIN TO IMPROVE RELIABILITY, FUNCTION OR DESIGN. FAIRCHILD DOES NOT ASSUME ANY LIABILITY ARISING OUT OF THE APPLICATION OR USE OF ANY PRODUCT OR CIRCUIT DESCRIBED HEREIN; NEITHER DOES IT CONVEY ANY LICENSE UNDER ITS PATENT RIGHTS, NOR THE RIGHTS OF OTHERS.

## LIFE SUPPORT POLICY

FAIRCHILD'S PRODUCTS ARE NOT AUTHORIZED FOR USE AS CRITICAL COMPONENTS IN LIFE SUPPORT DEVICES OR SYSTEMS WITHOUT THE EXPRESS WRITTEN APPROVAL OF FAIRCHILD SEMICONDUCTOR CORPORATION. As used herein:

1. Life support devices or systems are devices or systems which, (a) are intended for surgical implant into the body, or (b) support or sustain life, or (c) whose failure to perform when properly used in accordance with instructions for use provided in the labeling, can be reasonably expected to result in significant injury to the user.
2. A critical component is any component of a life support device or system whose failure to perform can be reasonably expected to cause the failure of the life support device or system, or to affect its safety or effectiveness.

## PRODUCT STATUS DEFINITIONS

### Definition of Terms

Datasheet Identification	Product Status	Definition
Advance Information	Formative or In Design	This datasheet contains the design specifications for product development. Specifications may change in any manner without notice.
Preliminary	First Production	This datasheet contains preliminary data, and supplementary data will be published at a later date. Fairchild Semiconductor reserves the right to make changes at any time without notice in order to improve design.
No Identification Needed	Full Production	This datasheet contains final specifications. Fairchild Semiconductor reserves the right to make changes at any time without notice in order to improve design.
Obsolete	Not In Production	This datasheet contains specifications on a product that has been discontinued by Fairchild semiconductor. The datasheet is printed for reference information only.

ON Semiconductor and  are trademarks of Semiconductor Components Industries, LLC dba ON Semiconductor or its subsidiaries in the United States and/or other countries. ON Semiconductor owns the rights to a number of patents, trademarks, copyrights, trade secrets, and other intellectual property. A listing of ON Semiconductor's product/patent coverage may be accessed at [www.onsemi.com/site/pdf/Patent-Marking.pdf](http://www.onsemi.com/site/pdf/Patent-Marking.pdf). ON Semiconductor reserves the right to make changes without further notice to any products herein. ON Semiconductor makes no warranty, representation or guarantee regarding the suitability of its products for any particular purpose, nor does ON Semiconductor assume any liability arising out of the application or use of any product or circuit, and specifically disclaims any and all liability, including without limitation special, consequential or incidental damages. Buyer is responsible for its products and applications using ON Semiconductor products, including compliance with all laws, regulations and safety requirements or standards, regardless of any support or applications information provided by ON Semiconductor. "Typical" parameters which may be provided in ON Semiconductor data sheets and/or specifications can and do vary in different applications and actual performance may vary over time. All operating parameters, including "Typicals" must be validated for each customer application by customer's technical experts. ON Semiconductor does not convey any license under its patent rights nor the rights of others. ON Semiconductor products are not designed, intended, or authorized for use as a critical component in life support systems or any FDA Class 3 medical devices or medical devices with a same or similar classification in a foreign jurisdiction or any devices intended for implantation in the human body. Should Buyer purchase or use ON Semiconductor products for any such unintended or unauthorized application, Buyer shall indemnify and hold ON Semiconductor and its officers, employees, subsidiaries, affiliates, and distributors harmless against all claims, costs, damages, and expenses, and reasonable attorney fees arising out of, directly or indirectly, any claim of personal injury or death associated with such unintended or unauthorized use, even if such claim alleges that ON Semiconductor was negligent regarding the design or manufacture of the part. ON Semiconductor is an Equal Opportunity/Affirmative Action Employer. This literature is subject to all applicable copyright laws and is not for resale in any manner.

## PUBLICATION ORDERING INFORMATION

### LITERATURE FULFILLMENT:

Literature Distribution Center for ON Semiconductor  
19521 E. 32nd Pkwy, Aurora, Colorado 80011 USA  
**Phone:** 303-675-2175 or 800-344-3860 Toll Free USA/Canada  
**Fax:** 303-675-2176 or 800-344-3867 Toll Free USA/Canada  
**Email:** [orderlit@onsemi.com](mailto:orderlit@onsemi.com)

**N. American Technical Support:** 800-282-9855 Toll Free  
USA/Canada  
**Europe, Middle East and Africa Technical Support:**  
Phone: 421 33 790 2910  
**Japan Customer Focus Center**  
Phone: 81-3-5817-1050

**ON Semiconductor Website:** [www.onsemi.com](http://www.onsemi.com)  
**Order Literature:** <http://www.onsemi.com/orderlit>  
For additional information, please contact your local  
Sales Representative

# Mouser Electronics

Authorized Distributor

Click to View Pricing, Inventory, Delivery & Lifecycle Information:

[Fairchild Semiconductor:](#)

[BS270](#) [BS270\\_D74Z](#)